

EGA10402V05AH Engineering Specification

1. Scope

This specification is applied to electrostatic discharge (ESD) protection. It is designed to protect the high-speed data lines against ESD transients. It has very low capacitance and fast turn on times makes it ideal for data and transmission lines with high data rates. According to the special property of device, we recommend not to use on such application as: DC/AC power line circuit.

For RoHS Compliance.

2. Explanation of Part Number

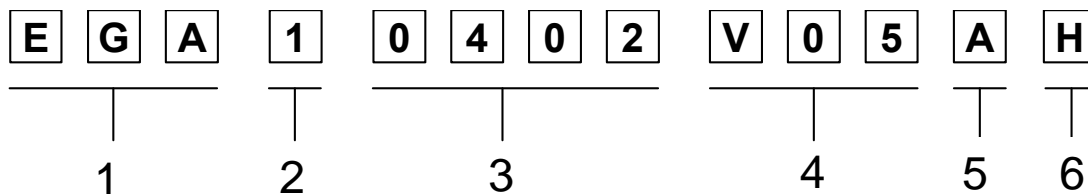

- 1 : ESDGUARD Series
- 2 : Elements
- 3 : Chip size, EIA
- 4 : Rating voltage, VDC
- 5 : Type A is suitable for IEC61000-4-2 Level 4
- 6 : "H" : High trigger voltage, typical 150V

3. Circuit symbol



4. Construction & Dimensions

- 4.1. Substrate : Ceramic (Alumina)
- 4.2. Encapsulate : Polymer
- 4.3. Electrodes : Silver Palladium (Ag/Pd)
- 4.4. End termination : Ag/Ni/Sn
- 4.5. Construction & Dimension :

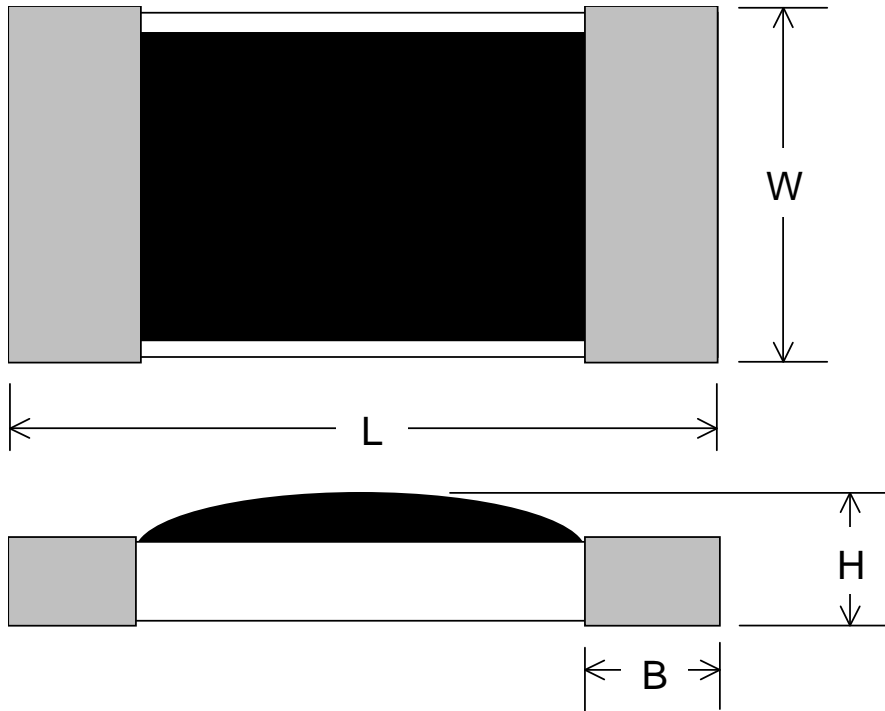

Unit: mm

L	W	H	B
1.0±0.1	0.5±0.1	0.34±0.1	0.2±0.1

5. General specifications

5.1 General technical data

Item	Typical
Continuous operating voltage	5 V
Leakage current	0.05 μ A
Trigger voltage	150V

5.2 Temperature Specifications

Operating Temperature range : -40°C to +85°C

Storage Temperature range : -55°C to +125°C

5.3 Environmental Specifications

Item	Specifications	Test condition
Bias humidity	$I_L \leq 10 \mu A$	90%RH, 40°C, rated voltage, 1000 hr
Thermal Shock	$I_L \leq 10 \mu A$	-40°C to 85°C, 30 min. cycle, 5 cycles
Full load voltage	$I_L \leq 10 \mu A$	Rated voltage, 85°C, 1000 hr
Solder leach resistance	$I_L \leq 10 \mu A$	260°C, 10s

I_L – Leakage current at maximum operating voltage, the maximum leakage current was measured at reliability test.

6. Performance Characteristics

	Symbol	Unit	Min.	Typical	Max.
Clamping voltage	Vc	V		30	
Capacitance, @1MHz	Cp	pF		0.2	0.5
Response time		ns			1
ESD voltage capability, Contact discharge mode		kV		8	15
ESD voltage capability, Air discharge mode		kV		15	25
ESD pulse withstand		pulses		1000	

Vc – Per IEC 61000-4-2, 30A@8kV, level 4, clamp measurement made 30 ns after initiation of pulse, all test in contact discharge mode

Cp – Device capacitance measured with 1Vrms

EGA Device I-V Curve

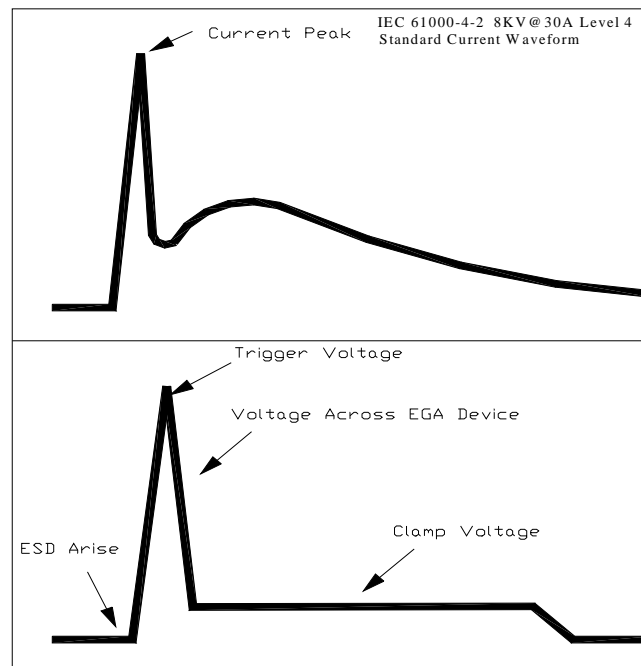

7. Taping Package and Label Marking

7.1. Carrier tape dimensions

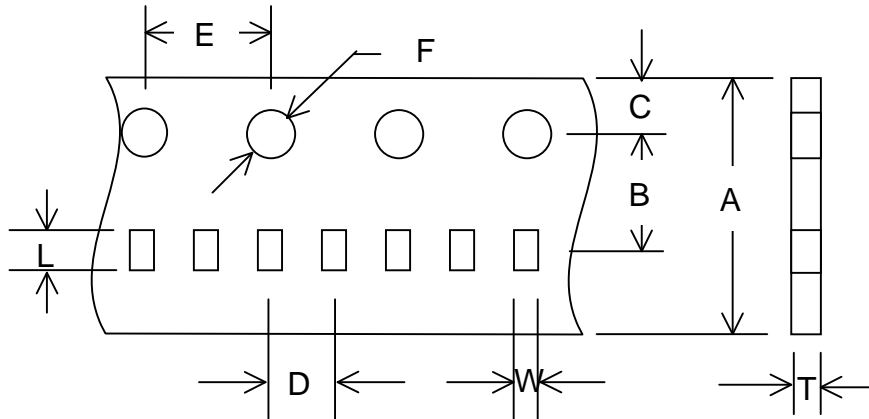

	0402
A	8.00±0.30
B	3.50±0.05
C	1.75±0.10
D	2.00±0.05
E	4.00±0.10
F	1.50±0.10
L	1.19±0.05
W	0.69±0.05
T	0.48±0.03

7.2. Taping reel dimensions

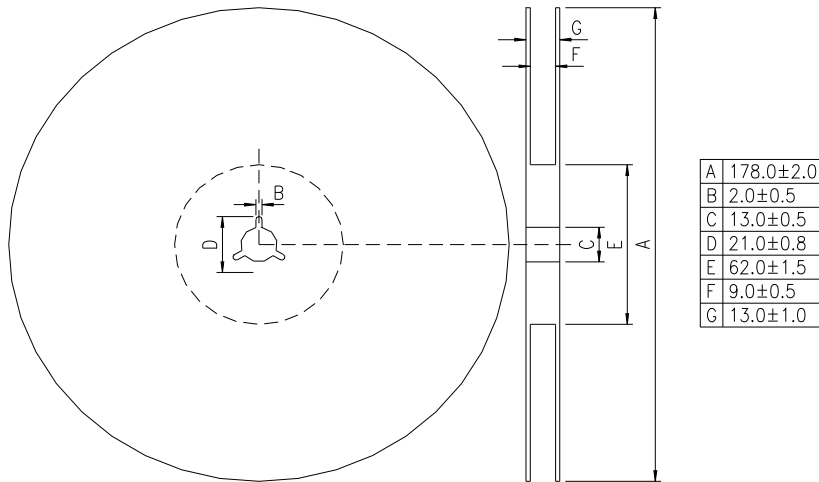

7.3. Taping specifications

There shall be the portion having no product in both the head and the end of taping, and there shall be the cover tape in the head of taping.

7.4. Label Marking

The label specified as follows shall be put on the side of reel.

- (1) Part No.
- (2) Quantity
- (3) Lot No.

* Part No. And Quantity shall be marked on outer packaging.

7.5. Quantity of products in the taping package

- (1) Standard quantity : 10000pcs/Reel for EGA10402V05AH
- (2) Shipping quantity is a multiple of standard quantity.

8. Precautions for Handling

8.1. Solder cream in reflow soldering

Refer to the recommendable land pattern as printing mask pattern for solder cream.

- (1) Print solder in a thickness of 0.15 to 0.2 mm.

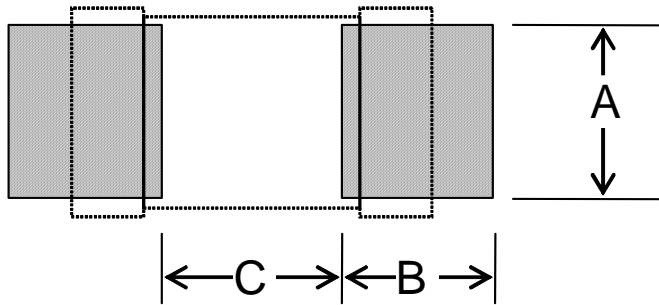

Unit : mm(inch)

A	0.50±0.1 (0.02±0.004)
B	0.50±0.1 (0.02±0.004)
C	0.50±0.1 (0.02±0.004)

8.2. Precaution for handling of substrate

Do not exceed to bend the board after soldering this product extremely. (reference examples)

- Mounting place must be as far as possible from the position, which is close to the break line of board, or on the line of large holes of board.
- Do not bend extremely the board, in mounting another components.
If necessary, use back-up pin (support pin) to prevent from bending extremely.
- Do not break the board by hand. We recommend to use the machine or the jig to break it.

8.3. Precaution for soldering

Note that this product will be easily damaged by rapid heating, rapid cooling or local heating.

Do not give heat shock over 100°C in the process of soldering. We recommend to take preheating and gradual cooling.

8.4. Recommendable reflow soldering

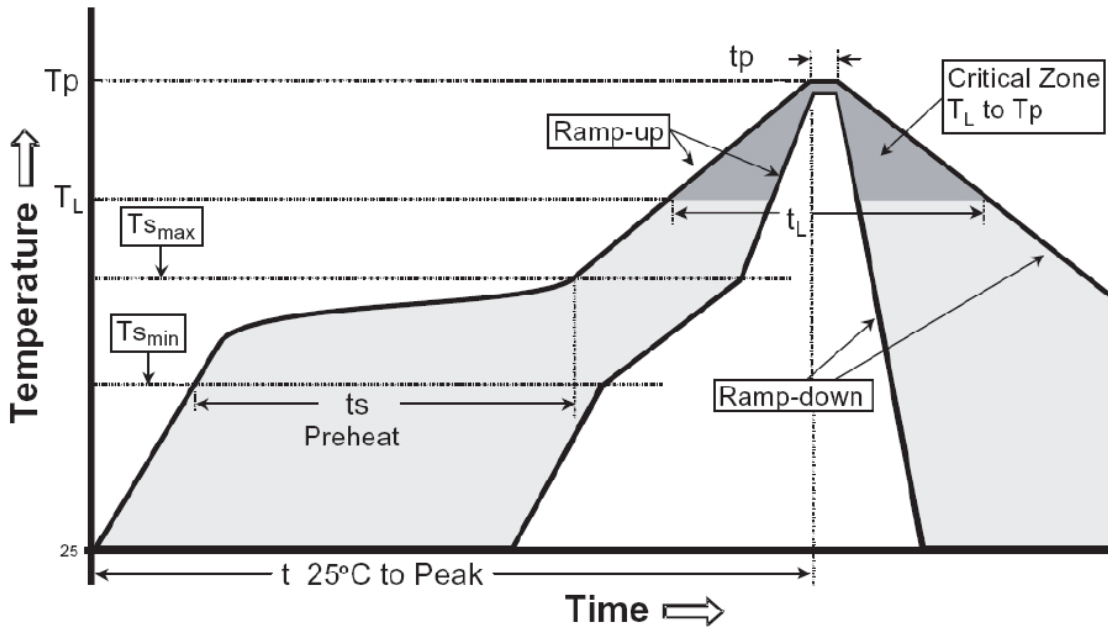

Reference IPC-020c-5-1

Profile Feature	Pb free Assembly
Average Ramp Rate (Ts max to Tp)	3 °C/second max
Preheat	
- Temperature Min (T_{smin})	150°C
- Temperature Min (T_{smax})	200°C
- Time(t_{smin} to t_{smin})	60-180 seconds
Time maintained above:	
- Temperature (T_L)	217°C
- Time (t_L)	60-150 seconds
Peak Temperature (T_p)	260°C +0/-5 °C
Time within 5 °C of actual Peak Temperature (T_p)	20-40 seconds
Ramp-Down Rate	6 °C/second max.
Time 25°C to Peak Temperature	8 minutes max

8.5. Soldering gun procedure

Note the follows, in case of using solder gun for replacement.

- (1) The tip temperature must be less than 280°C for the period within 3 seconds by using soldering gun under 30 W.
- (2) The soldering gun tip shall not touch this product directly.

8.6. Soldering volume

Note that excess of soldering volume will easily get crack the body of this product.

8.7. Taping Package Storage Condition

Storage Temperature : 5 to 40 °C

Relative Humidity: < 65%RH

Storage Time : 12 months max