

◆ **Feature**

1. Automatic process.
2. Available in magnetically shielded.
3. New designed terminal for low cost.
4. Low DC resistance.
5. Low profile and high currents.
6. RoHS compliant.



◆ **Application**

Excellent for power line DC-DC conversion applications used in power switching, such as Mobile phone, MP3 / MP4, DSC / DVC, PDA / GPS, Portable Hard Disk / TV.

◆ **How to Order**

IPC 5010 F 3R3 N A1
 (1) (2) (3) (4) (5) (6)

- (1) Product Series
- (2) Dimensions
- (3) Model code
- (4) Inductance Code
- (5) Inductance Tolerance Code: M-±20%, N-±30%
- (6) Control S/N

◆ **Dimension**

Unit: mm

Series	A	B	C	D	E	F	G
IPC5010F Series	5.0±0.2	4.9±0.2	1.0 max.	2.7 typ.	1.16 typ.	2.0 typ.	1.5 typ.

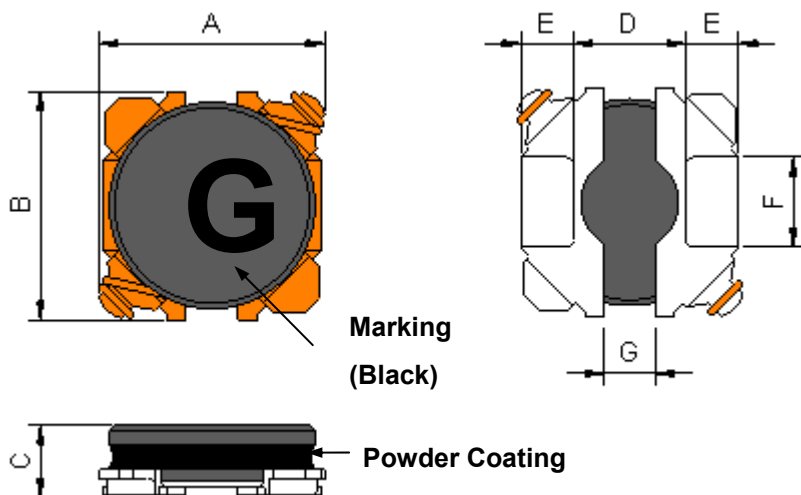

◆ Specification

Part Number	Inductance L (μH)	Rated Current		DCR (mΩ) ±20%
		I _{RMS} (A)	I _{SAT} (A)	
IPC5010F-1R0N-A1	1.0	1.9	1.8	59
IPC5010F-1R5N-A1	1.5	1.7	1.5	75
IPC5010F-2R2N-A1	2.2	1.6	1.2	90
IPC5010F-3R3N-A1	3.3	1.45	1.05	120
IPC5010F-4R7M-A1	4.7	1.35	0.8	140
IPC5010F-6R8M-A1	6.8	1.2	0.7	180
IPC5010F-100M-A1	10	1.1	0.65	220
IPC5010F-150M-A1	15	0.93	0.53	310
IPC5010F-220M-A1	22	0.75	0.47	450
IPC5010F-330M-A1	33	0.57	0.35	680
IPC5010F-470M-A1	47	0.45	0.3	1100

Note:

1. Test Frequency - L : 100KHz / 0.1Vdc
2. Testing Instrument - L : HP4285A, RDC : Chroma 16502
3. Heat Rated Current (I_{rms}) - Based on temperature rise (ΔT : 40°C TYP.).
4. Saturation Current (I_{sat}) - Based on inductance change ($\Delta L/L_0$: $\leq -30\%$) @ ambient temp. 25°C

◆ Package

Dimensions	Height			
	1.0 mm	1.2 mm	1.5 mm	1.6~2.0 mm
3.0x3.0 mm	IPC3010F	IPI2D11N	IPI2D14N	IPI2D18N
		IPC3012F	IPC3015F	IPC3020F
4.0x4.0 mm	IPC4010F	IPI3D11N	IPI3D14N	IPI3D16N
		IPC4012F	IPC4015F	IPC4018F
5.0x5.0 mm	IPC5010F	IPI4D11NT	IPI4D14N	IPI4D18N
		IPC5012F	IPC5015F	IPC5020F
Package				
Standard Packing Quantity (pcs/reel)		3000		